

Indoor Laminate flooring Guide

PARADOR

living performance

Table of contents

Parador Laminate Flooring Technical Aspects	page 4
The right choice	page 5
Installation at a glance	page 6
Installation rules.....	page 7 - 9
Requirements on the subfloor.....	page 10
System-compatible underlays.....	page 11 - 12
Methods of installation.....	page 13
Installation of laminate flooring.....	page 14 - 16
Disassembly of laminate flooring	page 17
Maintenance, cleaning and repair.....	page 18 - 19
Tools, transport, storage and accessories	page 20
Frequently asked questions.....	page 21
Quality standards.....	page 22
Checklists	
• Sample of Acceptance Protocol.....	page 23
• Subfloor heating.....	page 24 - 25
• All-over adhesion.....	page 26

Parador Laminate Flooring Technical Aspects

Laminate Flooring Composition

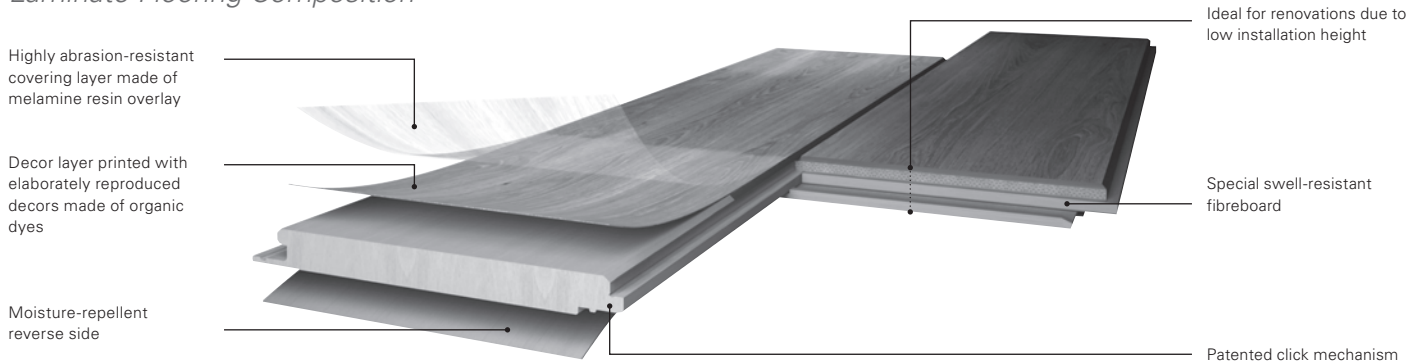

Finest technology

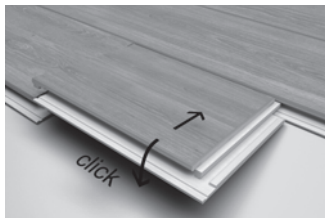

Innovative click system
AUTOMATIC-CLICK system with long and end edge locking. Particularly easy - particularly stable.



Patented installation system
Patented click mechanism with SAFE-LOCK profile: Simply put the planks together and securely click them into place.



Increased antistatic
Increased conductivity reduces electrostatic charge.

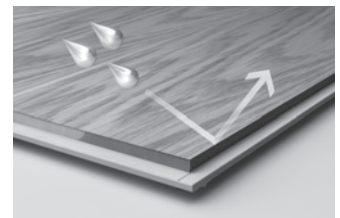

Excellent swell-protection
The swell-resistant fibreboards and the all-round edge impregnation provide 60 % better swelling protection than the European Standard 13329. The whole laminate profile is impregnated on both the long and end side. For reliable protection against moisture.

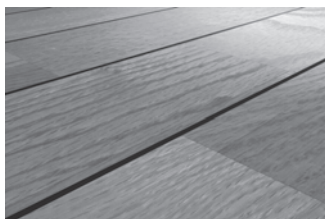

2-sided V-joint
The bevelled long edges help the generous length effect and create an extra optical depth in the room.

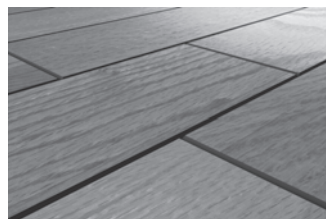

4-sided V-joint
The all-round bevelled long and end edges result in a pattern with the charm and elegance of a real, solid wood flooring, as each single plank is emphasised.

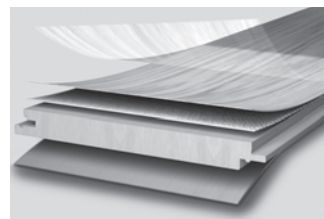

Highest wear rating
Extraordinary know-how is also evident from top innovative achievements. A unique glass fibre layer technology guarantees the highest wear rating of 34 on Laminate Classic 1060.

Ranges of application

Bringing your ideas to life is both fast and easy with Parador Laminate Flooring. These high-quality brand-name laminate planks with their patented Click-mechanism are installed easily in no time, they are also very hard-wearing and extremely easy to care for. The huge selection of different formats and installation patterns, brilliant colours and surface textures offers something to suit any room and decorating style. With a laminate floor by Parador you can be sure to have uncompromisingly high brand-name quality under your feet. Laminate flooring can be used in all domestic areas of living, depending on the usage it may also be used in commercial applications like offices or shops. The flooring is not suitable however for use in wet or moist rooms.

The right choice

One kind of laminate flooring is not like the other. Before the actual purchase, you should check and consider which type of laminate flooring is the best fit for your individual taste and requirements. Some important aspects here besides the brilliance of the décor, the swelling properties of the substrate (i.e. the moisture protection) and the quality of the Click-connection are the different performance classes and the insulation properties for transmission and ambience sounds.

Quality features

The quality of a laminate floor is not mainly determined by its so-called abrasion-value, which is derived solely from the grammage of the overlay that is being used. It is rather the sum of a multitude of material characteristics that results in the overall quality of a laminate floor (and determines its ability to cope with the strains in its required application areas). Two essential areas here are the substrate and the Click-connection. Because one click is not like the other! As a substrate Parador is using only fibreboards with a very high density (HDF-boards), which makes a significant contribution to the stability of each and every flooring board. A laminate flooring element with extremely low abrasive wear values (i.e. high Taber index) and a „soft“ substrate (like particleboard or MDF) is not likely to please its owners as they soon may notice indentations in the surface of their floor. So we conclude that the density of the substrate is what determines the required resistance against unwanted indentations in the floors' surface.

Quality-Standard EN 13329

The laminate flooring standard EN 13329 divides laminate flooring products into the so-called „Recommended utility classes“ by looking at certain quality features. This system is independent from the flooring manufacturers and offers consumers some guidance as to what a particular laminate flooring product should be able to do for them.

Installation at a glance

Thanks to its easy Click-mechanism Parador Laminate Flooring is fast and easy to install even without any previous knowledge. Here are the most important steps at a glance:



1. Unroll the underlay and put it on the prepared subfloor.



2. Center and align the planking area and cut the first row to size.



3. Use the spacer wedges to guarantee the expansion space of at least 8 - 10mm towards all walls and structural parts within the room.



4. The last board of the first row is cut to the right size - don't forget to include the wall spacing. The cut-off piece is used as the starting piece for the second row.



5. Start your next row from the left hand side like before. Simply click together the planks' longitudinal sides. The use of glue is not required here.



6. Join the short end sides together using a hammering block. Continue to install the rest of the room in this manner. (Laminate Flooring Trendtime 1 and 2 are featuring a different type of locking mechanism on the shortend side. Details on page 13.)



7. Use a cut-off piece to transfer the profile of the wall to the last row of planks.



8. Cover the gaps all around the flooring area with matching skirtings from Parador's wide selection.



9. You are done!

More detailed information on all installation topics starts at page 13.

Prior to installation please refer to and obey the rules of installation that are stated on the following pages. Paying attention to these rules and advice is a prerequisite for successful installation and also guarantees that your newly installed laminate flooring will be a long-term asset.

Installation rules

These installation rules and the step-by-step installation process that is shown here are universal. The package inserts however, may contain further, more specific or even deviating instructions or rules for a particular product that are mandatory and ought to be followed.

1. Inspection for material defects

Inspect your laminate flooring boards thoroughly for their quality prior to and during installation. Flooring planks with visible defects or damages must not be installed. The installation must take place under daylight conditions or with excellent artificial light to make sure that any possible damages or faulty planks can definitely be detected.

2. Acclimatising prior to installation

The laminate flooring elements must acclimatise for a period of at least 48 hours at temperatures above 17°C and humidity levels between 50 - 65 % in that room in which they are to be laid. That means the closed packages have to adjust to the climatic conditions in the room. If the climatic conditions in the storage location and the installation room are considerably different, the acclimatisation period should be longer. If the climate differences are very small the acclimatisation time may be shorter. Please store the packages flat on a base without opening them. Paying attention to these guidelines is especially important for new buildings, because humidity levels tend to be particularly high here.

3. No installation in areas subject to splashing water ***No installation in permanently moist rooms / wet zones***

Laminate flooring must not be installed in areas where splashing shower water may get onto the floor. Standing water will permeate into the laminate flooring boards and can lead to permanent damages. Laminate flooring should not be installed in permanently moist rooms or wet surroundings (saunas, small bathrooms etc.) because the danger of penetration with moisture can never be ruled out completely. If laminate flooring is supposed to be installed in a bathroom, it is important to make sure that it is not installed in areas subject to splashing water (i.e. shower, bathtub, lavatory or sink) and that the relative humidity in the room stays within the normal range between 50 and 65% continually. Any formation of puddles and moisture penetration must be avoided all around the corners of the room, for the joints as well as for the whole flooring area.

Installation rules

4. Condition of the subfloor

Any existing subfloor must be even (max. tolerance 3 mm per 1 m in length), dry and sufficiently stable. Larger depressions should be evened out using standard commercial fillers. The surface of the subfloor should be free of cracks and without any breaks or tears. Loose subfloors or insufficiently stable subfloors (PVC-/ textile flooring) need to be removed.

Please also refer to the information in the special chapter on Subfloors.

5. Moisture barrier with mineral subfloors

Generally, when installing on any dry, mineral subfloor a 0.2mm thick Polyethylene foil or alternatively Duo-Protect should always be used as a moisture barrier to prevent any residual moisture getting through to the backside of your laminate flooring. The purpose of the Polyethylenefoil is that of a moisture barrier only and the joints of the foil need to overlap approx. 30cm and need to be glued together. In no way does the PE-foil act as waterproofing for the building!

See also the chapter on Underlays.

6. Keeping expansion joints / wall spacings

Being a derived timber product, the substrate of laminate floorings is subject to swelling and shrinking processes depending on the climatic conditions, just like natural timber. That is why an installed laminate flooring requires sufficient spaces, called expansion gaps, towards all fixed constructional parts, i.e. walls, sustainer, heating pipes and the like. Furthermore, expansion gaps are required if the installation area exceeds certain defined values in length and width (see installation rule 7). One of the most common installation mistakes is actually insufficient wall spacing. Often, this will only become evident during the summer months when higher temperatures and humidity levels lead to a swelling of the laminate flooring.

The expansion gap/ wall spacing should be at least 8mm* on each side; with large areas it should be proportionately more. For laminate flooring the rule-of-thumb is: Every meter of installed flooring requires at least 1.5mm of expansion space on both sides of the room. (Example: Room width 5m = min. 8mm expansion gap on each side).

*Note: 15mm minimum with relative humidity > 65%.

Even if the installed material abuts only on a single point in the room the „floating material“ may start to warp and press on. Popular areas where this is repeatedly happening are architraves, transition areas to stairs, heating pipes as well as end profiles.

Installation rules

Heavy pieces like for example kitchen islands and closets (where movements of the flooring are possible in one direction only) require the expansion space on one side to be doubled. For heavy pieces and fitted furniture (e.g. fitted kitchens, built-in closets or aquariums) we recommend having them assembled prior to installation of the flooring. The flooring boards however should be laid to reach just under the base allowing easy dismantling of the flooring at any time. All along the walls the expansion gaps are covered with skirtings, in other places special flooring profiles are used. With metal architraves you can also use Acrylic sealants. All of the above is part of and can be found with the Parador range of accessories.

7. Layout of expansion gaps

Due to the fact that the laminate flooring will shrink and expand depending on the climatic conditions – as described earlier – the following situations do require additional expansion joints / spaces of at least 8mm:

- With larger areas (exceeding 8 x 12m)
- With angular areas
- With installations that cover more than one room

Conceal expansion gaps with the suitable adapting or other transition profiles.

Note: Liability for missing expansion gaps or joints is always with the installer.

8. Installation patterns

Laminate flooring can be installed either in a symmetric or in a random, asymmetric pattern. In either case it is imperative that between rows the short-end joints are staggered at least 40 cm; 15 cm for Trendtime 2.

9. Installation direction / incidence of light

For optical reasons the longitudinal sides of the planks should be installed so that they run parallel to the incidence of light. That means, the longitudinal side runs in the same direction as the light. When several windows are present, please make your decision based upon the largest one of them. With extreme floor plans the decision for a certain installation direction can also be based upon the specific room layout. (See installation rule 10)

10. Installation direction / floor plan

Again, for optical reasons the longitudinal sides of the flooring should run across to the longitudinal side of the room. That will make the room look larger and also give it a slightly more "square" appearance so it won't look quite as narrow and tube-like.

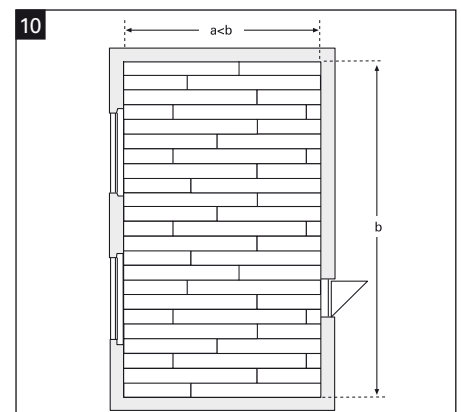
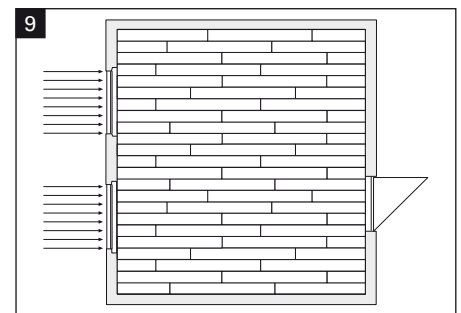
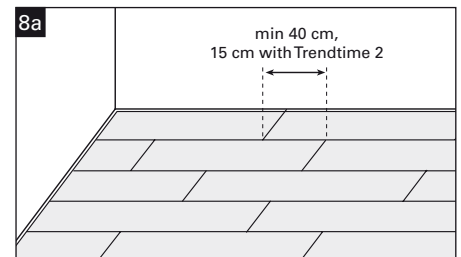
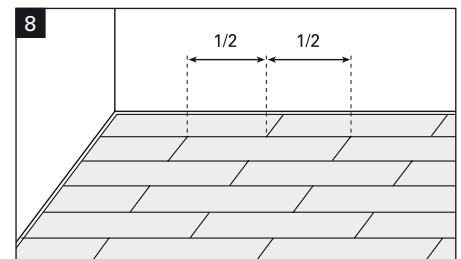
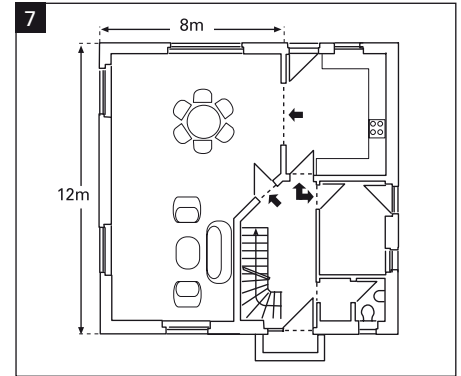

Requirements on the subfloor

- Basic requirements for installing laminate flooring are that the substrate is stable, clean, dry and even.
- Irregularities exceeding 3mm per 1m have to be evened out with a suitable filler/ spackle.
- When installing on an old hardwood floor or on particleboard flooring any loose planks need to be screwed with the sub-structure to help silencing potential squeaks in the old floor. The new floorboards should be installed in transverse direction to the old boards.
- For both stability and health reasons, textile floors are not suitable as a substrate and have got to be removed.
- Installation on PVC-, CV- and linoleum-flooring is possible only if the floor coverings are glued-down over their entire surface and no loose areas are present. Also, the floor coverings must not have subfloor heating underneath.
- Screed floors must not exceed the following residual moisture levels:

	Anhydrite flow screed	Cement screed
without subfloor heating	max. 0.5 CM %	max. 2.0 CM %
with subfloor heating	max. 0.3 CM %	max. 1.5 CM %

Generally, moisture level measurements of screed floors should always be conducted with a suitable measuring device. For reasons of precaution a 0.2mm thick PE-foil should always be used as a moisture barrier on top of the screed floor (the individual foil strips need to overlap at least 30cm, overlaps are fixed with adhesive tape; all around the room the foil needs to run up the walls for several centimeters and can be trimmed down with a cutting knife after the skirtings have been installed). Alternatively, you can use Parador underlays with transmission noise insulation and integrated moisture barrier.

System-compatible underlays

Generally, between any floating laminate flooring boards and the subfloor a suitable underlay has to be inserted. Underlays are useful for reducing transmission noise and ambience noise, evening out minor irregularities and provide the necessary moisture barrier for mineral subfloors. For existing subfloors like for example dry flooring planks or particleboard flooring the only thing required is an underlay that provides transmission noise reduction. A moisture barrier must not be used in these cases, because this can promote the growth of mould fungus in the subfloor. With all mineral substrates (screed, concrete, tiles) the use of a moisture barrier is vital, otherwise the (residual) moisture coming from your subfloor can get to your flooring and that in turn may lead to cupping or crowning of your floorboards. Additionally, the use of a product for transmission and ambience noise reduction or a combination-product is required. For Akustik-Laminate Flooring (Laminate Flooring with integrated transmission noise insulation) the use of a 0.2 mm thick PE-foil is required with installations on any kind of mineral subfloors as an additional moisture barrier.

Parador is offering the right underlay for every purpose:

Uno-Protect

The highly resilient underlay for all dry substrates.

- Can be used on wood planks, particle boards, PVC floors, linoleum floors etc.
- Good impact noise insulation with a minimal material thickness of 2.5 mm (+22 dB improvement)
- High compressive strength and dimensional stability up to 20,000 kg/m².
- Impregnated against mould infestation.



Duo-Protect

The 2-in-1 underlay with moisture protection and impact noise insulation combined.

- Especially for new construction: dual damp and moisture protection against residual moisture in concrete, screed and tiles.
- Good impact noise insulation with a minimal material thickness of 2.9 mm (+22 dB improvement).
- High compressive strength and dimensional stability up to 20,000 kg/m².
- Impregnated against mould infestation.
- Saves time: impact noise insulation and moisture protection can be installed in a single process.



Plan-Protect

The practical impact noise underlay made of natural wood fibres.

- Can be used on wood planks, particle boards, PVC floors, linoleum floors etc.
- Good impact noise insulation with a material thickness of 5.5 mm (+19 dB improvement).
- Optimal levelling of slight uneven patches of floor combined with high compressive strength.
- A purely natural product made of wood fibres.

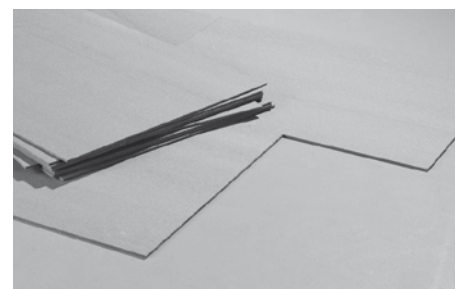

System-compatible underlays

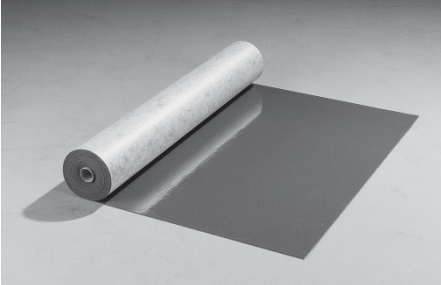

Akustik-Protect 100

The high-tech acoustic mat offering ambient noise and impact noise insulation.

- Especially developed for use under floating laminate, engineered wood and solid wood flooring.
- Very good ambient noise insulation properties thanks to high inherent weight of 1.8 kg/m² with a thickness of only 1.8 mm.
- Optimal impact noise insulation - no additional impact noise protection is necessary.
- Aluminium-covered reverse side.

Akustik-Protect 200

The high-tech acoustic mat offering ambient noise and impact noise insulation.

- Especially developed for use under floating laminate, engineered wood and solid wood flooring.
- Very good ambient noise insulation properties thanks to high inherent weight of 2 kg/m² with a thickness of only 2 mm.
- Optimal impact noise insulation - no additional impact noise protection is necessary.

Akustik-Protect 300

The high-tech acoustic mat offering ambient noise and impact noise insulation.

- Especially developed for use under floating laminate, engineered wood and solid wood flooring.
- Very good ambient noise insulation properties thanks to high inherent weight of 2.8 kg/m² with a thickness of only 2 mm.
- Optimal impact noise insulation - no additional impact noise protection is necessary.
- Aluminium adhesive tape to seal the joints between the lengths and aluminium-covered reverse side for improved moisture protection from underneath.

Ambience and transmission sounds

Talking about the acoustic performance of laminate flooring, we have to distinguish between ambience and subsonic or transmission noises. Sounds that can be heard underneath the sound source are called transmission noise. When laminate floorings are installed this type of sound has to be considered, because laminate flooring tends to be relatively noisy due to the hardness of the material and the fact that the sound waves are transmitted to other objects (i.e. ceiling) very easily. This is why some kind of transmission sound insulation is used whenever laminate floorings are being installed. The insulation layer works by decoupling the laminate flooring from the subfloor which leads to the insulation of sound waves. The transmission noise is measured in a standardised test procedure and is defined as the so-called transmission sound level. The higher this value, the „quieter“ it will be in the rooms underneath.

The term ambience sounds in contrast, describes the sounds that can be heard in the room where the sound source itself is located. Laminate floors develop this type of sound due to the combination of floating floor installation and the hardness of the material (large sound body with a relatively low mass). This type of sound cannot be measured quite as exactly and there is no standardised test procedure that could be used to define improvements of the ambience sound level. Also, the perception of ambience sound is something very individual that varies greatly among people (quiet/ noisy; dull/ clear etc.).

With the current range of Akustik-Floors Parador has a group of products available that offer a significantly improved performance both in terms of transmission and ambience sounds - visit your local dealer to see and hear it for yourself!

Methods of installation

1. Floating floor installation

Installations where the laminate flooring elements are installed without a permanent connection to the subfloor, i.e. the individual flooring boards are connected only with each other, are called „floating floor installations“. The flooring can move freely (‘‘float’’) on the underlay/subfloor. Thanks to the convenient Click-technique installing Parador Laminate Flooring is particularly fast and easy to do even without any previous knowledge and therefore this has become the most popular method of installation.

2. All-over adhesion

In special cases, i.e. at the request of the end user, it may be necessary to glue the laminate flooring elements onto the subfloor, despite the fact that all laminate flooring elements are generally designed for ‘‘floating floor installations’’.

When doing that please note the enclosed checklist on All-over adhesion.

3. Installation on subfloor heating

Parador Laminate Flooring is suitable for both ‘‘floating floor’’ and ‘‘all-over adhesion’’ installations on hot-water-type radiant heated substrates. The floorings’ good heat transfer resistance is the basis for efficiently operating radiant heat systems. Always use Duo-Protect as an underlay for ‘‘floating floor’’ installations on subfloor heating.

For installations on electric subfloor heating systems please contact the Parador Applications Technology.

Please also read and follow our enclosed checklist on Subfloor heating!

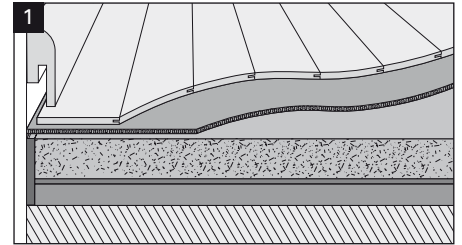

Laminate Flooring on Duo-Protect / Mineral screed

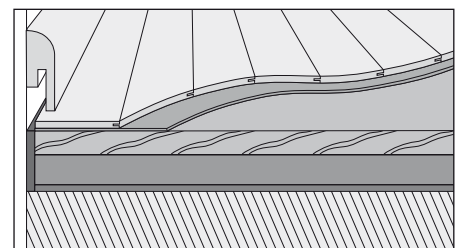

Laminate Flooring on Uno-Protect / Hardwood planks

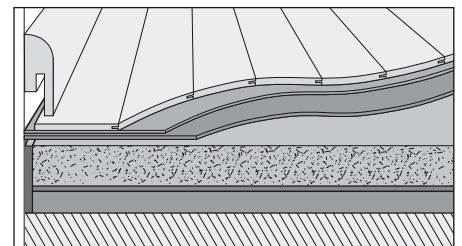

Laminate Flooring on Uno-Protect / PVC / CV / Mineral screed

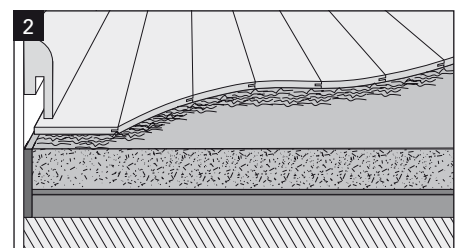

Laminate Flooring, all-over adhesion

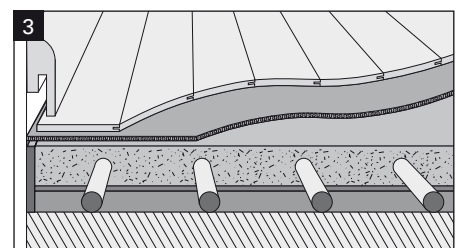

Laminate Flooring on Duo-Protect / Hot water-type subfloor heating

Installation of Laminate Flooring

SAFE-LOCK profile and AUTOMATIC-CLICK system

Preparations

Now that you are aware of the most basic regulations and requirements and after the underlay has been installed, let us come to the installation of the laminate flooring planks itself: In order to achieve a similar appearance of the first and last rows, measure the width of the room transversely to the installation direction and center the width of the flooring planks. Mix the contents of several packages together throughout the installation process to achieve a natural, even look of the flooring area overall. The last flooring plank of each row is cut to size and the sawn-off piece - as long as it is not shorter than 20cm - is used to start the next row. Between rows the cross joints should be staggered by at least 40 cm (min. 15 cm with Trendtime 2) forming a „random connection“. For installation of Trendtime 5 we recommend a symmetric installation pattern (also called “English pattern”). Please inspect all boards prior to installation and use only impeccable elements for your flooring.

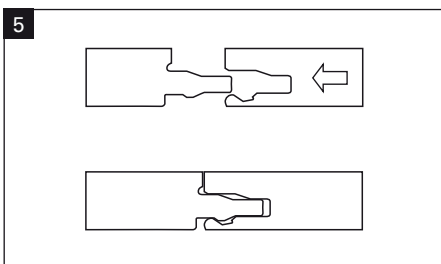
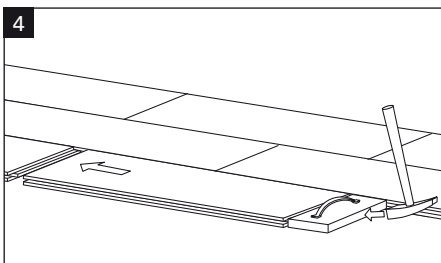
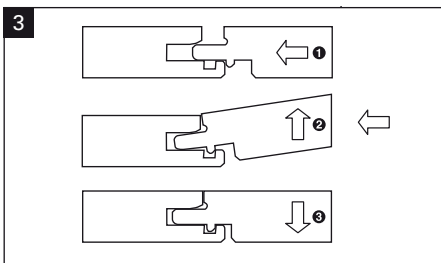
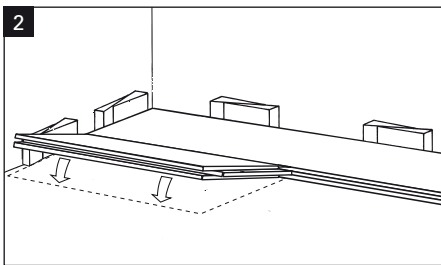
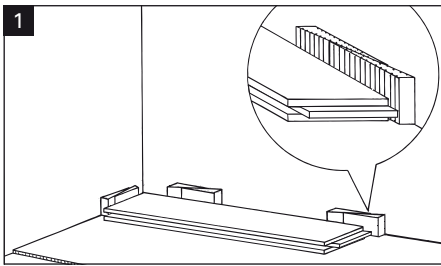
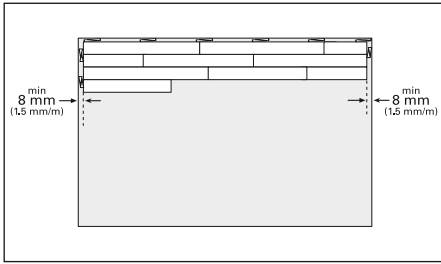

Installation Sequence

Fig. 1: Begin by removing the longitudinal tongues of the entire first row of planks with a saw. Start laying the first row in such a way that the groove of the short-end side and the sawn-off edge are facing the wall. Start in the left hand corner of the room. Use the Parador spacer wedges to ensure the required 8-10 mm* expansion space to the wall. If the wall is not straight see Fig.10. Start pushing the short ends of the first row together until they interlock. Check and make sure the flooring elements are in good longitudinal alignment.

*Note: 15mm minimum with relative humidity > 65%.

Fig. 2 + 3: The first plank of the second row is connected with the first row on its long edge, as follows: (1) Push the plank on the floor in front of the first row. (2) Tilt the plank slightly upwards to the point of engagement (15-25°) (3) When lowered, the plank engages in such a way that it press-fits.

Fig. 4 + 5: SAFE-LOCK: As with all other planks, the following floor plank should be locked into place lengthwise as described. Important: When locking the plank in position lengthwise, please ensure that the space between the short-end side of the plank and the previous board is as small as possible. The planks should then be pushed together horizontally at the short-end side using the hammering block. The SAFE-LOCK-profile with its special edge design locks automatically. IMPORTANT: For information on disassembling flooring planks please refer to the special Instructions for Disassembly on page 17.

Installation of Laminate Flooring

SAFE-LOCK profile and AUTOMATIC-CLICK system

Fig. 6: AUTOMATIC-CLICK: The next board – and all the others that 6 follow – is inserted lengthwise as described above. Before lowering the board the short end side is pushed close to the adjoining board.

Fig. 7 + 8 + 9: AUTOMATIC-CLICK: The longitudinal joint of the plank is then locked by simply pressing the two boards together and pushing downwards. (Fig. 3). Before locking the short-end joint, always make sure that the longitudinal joint is locked completely along the entire length of the board. A slight hit (with your hand) is all that is needed to lock the short-end joint.

Fig. 10: Measure the end piece with a try square and cut to length. Don't forget to provide the expansion space to the wall! If you are using a jig saw, have the top surface of the board face downwards, if you are using a table saw, let it face upwards.

Fig. 11: SAFE-LOCK: Carefully insert the end piece with the Parador metal heel bar.

Fig. 12: Fit the last row using a scrap piece of flooring. Remember to consider the expansion gap of 8–10 mm from the wall!

Installing the SAFE-LOCK profile with glue:

Apply Parador D3-glue continually but sparingly(!) onto the groove all along the short and long side (do not put any glue onto the tongue). Boards with glue need to be installed immediately. As an indication that sufficient amounts of glue have been applied, you should see glue emerging along the full length of the joint when the planks are being pushed together.

Removing excess glue from the surface is best achieved by allowing the glue to stand for a few minutes until tacky, then using the spatula to simply scoop up any leftovers. Use a clean, moist cloth for the final wiping.

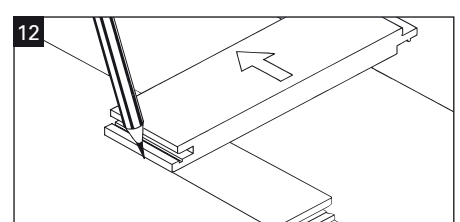
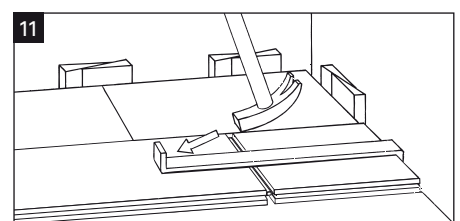
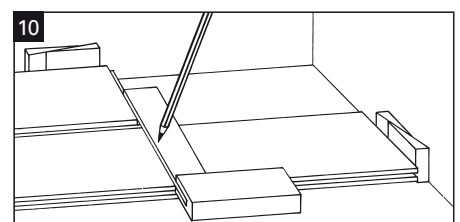
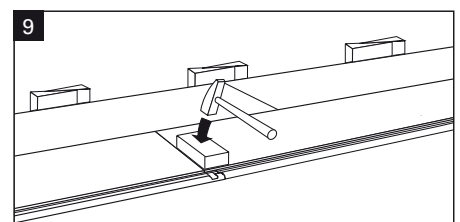
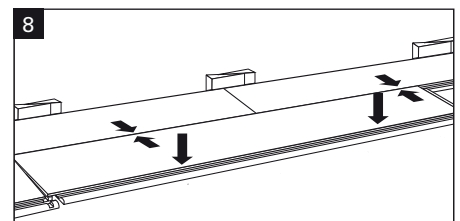
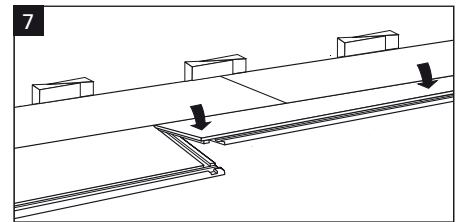
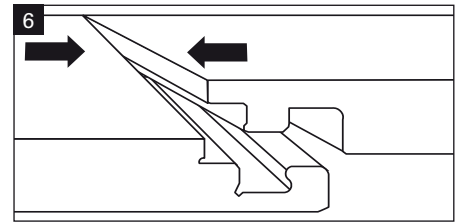

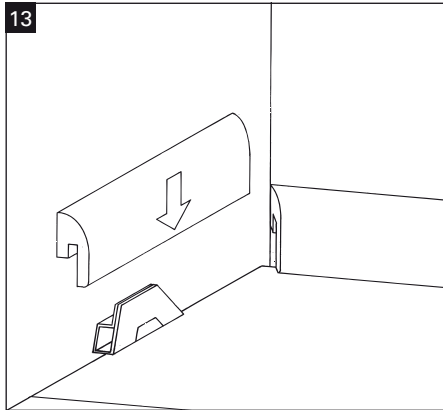

Installation of Laminate Flooring

SAFE-LOCK profile and AUTOMATIC-CLICK system

Fig. 13: The floor is ready for use as soon as the installation is complete. Remove the spacer wedges and attach the Parador skirtings with patented Clip-technique.

Fig. 14: If the wall is not straight: Align and position the first row of flooring boards within the room just the way you want them to be installed. Use a scrap piece of flooring to transfer the course of the wall onto the row of boards and saw off accordingly.

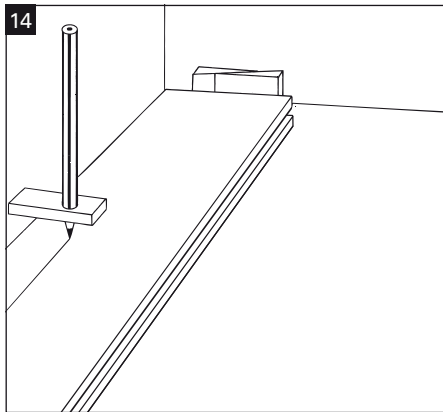
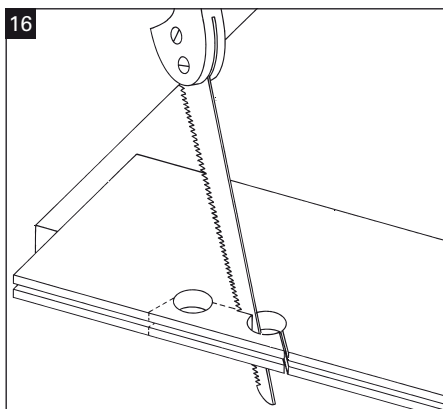
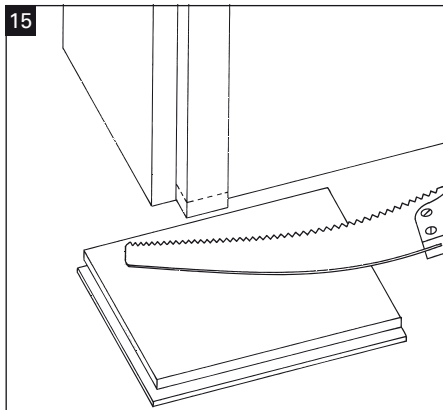

Fig. 15: How to shorten a door frame: place a piece of residual board on top of the underlay against the frame (décor side down) and saw the frame off along the board.

Fig. 16: How to fit your floor around heating pipes: the diameter of the hole in the board should be 10 mm larger than the pipe itself. Mark the spot, drill the holes and saw off at an angle of 45° as shown in the illustration. Glue in the sawn off piece. Don't forget the expansion gap here either.



Disassembly of laminate flooring

Fig. 17: Disassembly of the *SAFE-LOCK* profile:

To disassemble installed boards without damage, on their grooved side lift the entire row of boards off the floor to the point of disengagement and pull the row out as a whole and away from the previous row. Now, put the planks back down on the floor in front of you. The short end sides are not disassembled by pulling but by transversely sliding the boards away from each other.

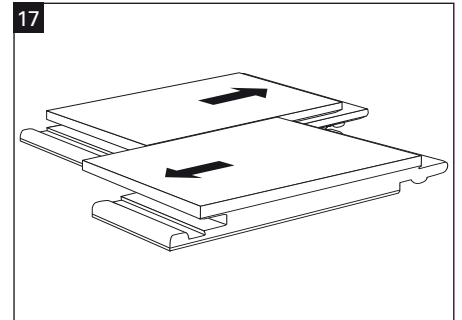
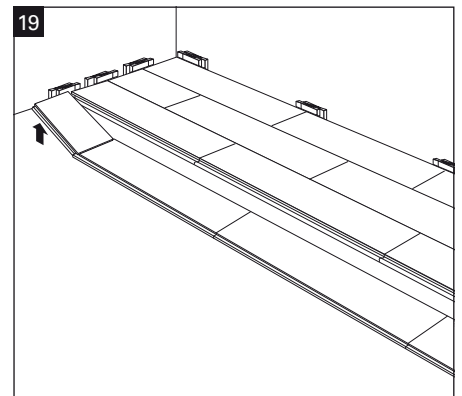
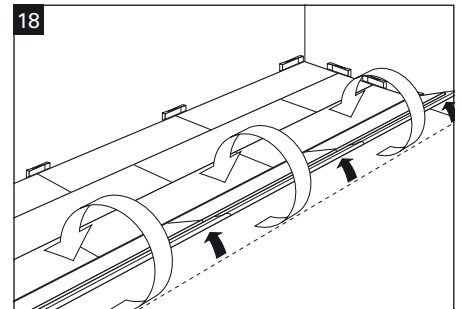

Fig. 18 + 19: Disassembly of the *AUTOMATIC-CLICK* profile:

To disassemble, lift the entire row of boards and pull them out of the previous row diagonally. Put the planks décor-side down on the floor in front of you (fig. 18). As shown in the picture, the short-end joints can easily be unlocked now by lifting them from left to right (fig. 19). Thus, the locking mechanism remains intact and the boards can be reused. Important: Avoid twisting the boards as this can damage the profile.



Cleaning, maintenance and conservation of value

Parador Laminate Flooring boards come with a melamine-resin-coated surface and are therefore particularly hard-wearing. To make the beauty of your new flooring last for a long time, please note the following tips for cleaning and maintenance procedures as well as conservation of value:

Avoiding damage

As with all other floor coverings, your new laminate floor should be protected from dirt particles by providing "walk-off zones" (outfitted with doormats/ carpet runners).

To protect the laminate flooring against scratches all chairs, tables and other movable furniture pieces need to be fitted with appropriate, soft felt glides.

Use only soft castors on office chairs, filing cabinets and wheeled containers.

Additionally, areas subject to heavy castor-traffic may be covered with special protective mats that are available in most stores specializing in office supplies.

Putting up additional wax-layers or adding other surface treatments to your laminate flooring or to its edges is not necessary, because these measures are neither going to improve the looks nor enhance the serviceability of the flooring.

We recommend regular dry cleaning of your laminate floor using a vacuum cleaner (brushes up!) and/or a broom. Wiping of the floor with a damp cloth is necessary only for severe soiling. When wiping, it is important to remember that the cloth always has to be extremely well wrung out so that never any puddles of standing water will form.

Maintenance

General advice on the maintenance of your laminate flooring:

- Relative humidity between 50 and 65% is the optimum condition for Parador Laminate Flooring as well as for your personal well-being.
- Sand and dirt can act like abrasive paper on your floors and should be avoided.
- Liquids spilled and/ or standing on the floor have to be removed immediately.
- Damp wipe only.
- Do not use any scouring / abrasive cleansers, no waxes, hot steam cleaners or polishes. They will cloud the floors' visual appearance.
- Fit furniture, tables and chairs with soft felt glides. Use only soft castors on office chairs and cover the main castor-traffic areas with commercially available protective mats.
- Do not use steam cleaners.

Cleaning, maintenance and conservation of value

Building contractor cleaning

- Remove drilling dust and other loose particles directly with a brush or vacuum cleaner.
- Remove adhesive streaks and residue with Glue Remover. To do this, put some glue remover onto a cloth and clean the soiled areas.
- Finally damp-wipe with Concentrated Cleanser (Wring cloth out well and avoid pools of water on the floor, mix cleanser and water in proportions 1:50).

Maintenance cleaning

- Remove dust, fluff and loose particles with a brush or vacuum cleaner (brushes up!).
- Wipe up localised dirt with a damp cloth.
- With severe soiling you can damp-wipe your floor with Concentrated Cleaner (mix with water in proportions 1:50). Take care not to allow any pools of water to form.

Stubborn stains

- Severe stains such as those from shoe polish, lacquers, tar, oil, grease, ink or lipstick are best treated with a cloth dipped in solvent. For this purpose you can use solvents such as acetone, nail polish remover or Petrol for home use. When using these, please obey all safety instructions and use solvents sparingly only on the respective areas.

Stain removal and levelling of slight scratches

- Using a cloth, apply a small amount of the Laminate Intensive Cleaner onto the respective area and polish off dry after a few minutes. Repeat this procedure if necessary. Finally damp wipe.

Repairing more severe scratches and damages

- The damaged areas can be repaired with a palette knife and Repair Paste.

Tools



When you want to install laminate flooring, you should have the following tools and devices handy: tape measure or folding rule, cutter, adhesive tape, pencil, jig or circular saw and hammer. Additionally you will need certain specialised installation accessories like for example the spacer wedges, metal heel bar and the hammering block, all of which are special Parador designs that your local dealer has available for you.

Transportation and storage

Avoid damage on your laminate flooring boards during transportation. Before you start the installation the closed original flooring packages should be stored in the room where they are to be installed for at least 48 hours to let them acclimatise. Make sure that the storage conditions are not causing any deformations on your flooring. Laminate flooring is to be stored only in closed rooms with product-compatible climate.

Accessories

In order to not only make the newly installed flooring look good but to give the whole room the perfect finishing touch you will need skirtings to form an attractive transition to the walls, also for the transition between two rooms flooring profiles are needed as well as probably some pipe covers. The Parador range of accessories provides you with a wide assortment of products for almost any application and room situation.

You can find the comprehensive range of Parador accessories, such as profiles, installation equipment and cleaning materials in the separately available accessories catalogue.

The most frequently asked questions

1. What is the reason for warping and cupping of flooring boards?

This happens with laminate flooring boards that have not completed their acclimatising period prior to installation. Please pay special attention to proper acclimatisation! That means: prior to installation let the closed flooring packages acclimatise for 48h on an even surface in that room where they are to be installed.

2. What is the reason for open joints between elements?

Often, the reason behind open joints in laminate flooring areas is that humidity levels within the respective room are (much) too low (material is drying out = shrinking). Compliance with the recommended humidity levels is extremely important here. Throughout the heating period ideal levels for humidity are at least 50-65 % at temperatures between 20 and 22°C.

3. What is the reason for a crowning floor?

Usually, a crowning floor is an indication that the flooring area abuts against the wall at some point or that an expansion joint may have become insufficient (heating pipe, door jamb, covering profile etc.). Please check each and every expansion space to make sure that these still provide the required room for movement. Even minimal contact at a single point can lead to crowning of the whole flooring area elsewhere.

4. What is the reason for edge swelling?



If the flooring is being cleaned too often with too much water or pools of fluids remain standing on the flooring instead of being taken up right away, this can lead to an effect called edge swelling. The reason behind this is that moisture permeates into the joints which leads to moisture-induced swelling of the derived timber product.

To prevent this, damp-wipe the floor only occasionally if absolutely necessary and remove any pools of liquid right away.

5. What is the reason for dull and cloudy looking laminate flooring areas?

Often, this problem is caused by inappropriate cleaning agents. Over time these unsuitable cleansers leave layers of build-up behind which act like a film-layer on the floor and lead to a cloudy look. To avoid this, stay away from any build-up containing cleansers like polishes or floor wax and preferably use the Parador Concentrated Cleanser instead.

Quality specifications

Feature	Norm	Requirements	PARADOR
1. Straightness of edges	EN 13329	max. ≤ 0.30 mm/m	max. ≤ 0.10 mm/m
2. Rectangularity	EN 13329	≤ 0.20 mm	≤ 0.10 mm
3. Height difference between joined elements	EN 13329	Average ± 0.10 mm Maximum ≤ 0.15 mm	Average ± 0.05 mm Maximum ≤ 0.10 mm
4. Gaps and joints between elements	EN 13329	Average ± 0.15 mm Maximum ≤ 0.20 mm	Average ± 0.05 mm Maximum ≤ 0.10 mm
5. Thickness swelling	EN 13329	NK 21 - 23 < 20 % NK 31 - 33 < 18 %	NK 21 - 23 < 16 % NK 31 - 33 < 10 %
6. Gross density of substrate	EN 316	≤ 825 kg / m ³ = MDF ≥ 825 kg / m ³ = HDF	≥ 870 kg / m ³
7. Block alignment	EN 13329	No specifications	± 2 mm
8. Emissions	 EN 14041	No specifications	RAL-UZ38 (Blue Angel) LGA „schadstoffgeprüft“
9. Inflammability	 EN 14041	To be specified acc. to EN 13501-1	C _{fi} s1
10. Quality monitoring	 EN 14041	FPC = Internal production monitoring	FPC and external control

For further information please refer to the Technical Data Sheets.

Acceptance protocol for installers

Mr. / Mr: _____ Order number: _____

Street address: _____ Protocol number: _____

Place: _____ Date: _____

Installation date: _____

Item No.	Quantity (target)	Quantity (actual)	Product / Service
1	_____ m ²	_____ m ²	Removal of old floor coverings (in m ²)
2	_____ m ²	_____ m ²	Installation of flooring
3	_____ m	_____ m	Installation of profiles
4	_____ m	_____ m	Installation of skirtings
5	_____ pcs.	_____ pcs.	Adjustment of doors
6	_____ pcs.	_____ pcs.	Adjustment of door jambs
7	_____ pcs.	_____ pcs.	Removal / exchange of floor planks

Comments / particularities: _____

Surface inspections of the installed flooring area are best carried out in a standing upright posture. Conditions of angular light or back light or deviations from the normal usage situation are not to be used for inspecting. The flooring does not show any defects or damages. The Cleaning and Maintenance Instructions for the specific type of flooring that has been installed were delivered to the customer/ buyer.

_____ Date, Place

Checklist for installation on hot-water-type subfloor heating

Generally, before installing the laminate flooring all mineral substrates have to be heated up to the point where no more damaging moisture is escaping from the subfloor. This applies throughout the whole year regardless of the season.

The cement floor/ slab has to be installed correctly according to the generally accepted rules of the trade (DIN = German Industry Standard). A curing period of at least 21 days has to be completed before the heating-up process can begin. For the heatingup process we recommend that you follow the chart on the bottom of this page or use the "Heating protocol" on the next page as your guide. Please pay attention to any additional instructions/ tips that your composition floor layer or heating contractor may have.

Heating chart for hot-water-type subfloor heating system

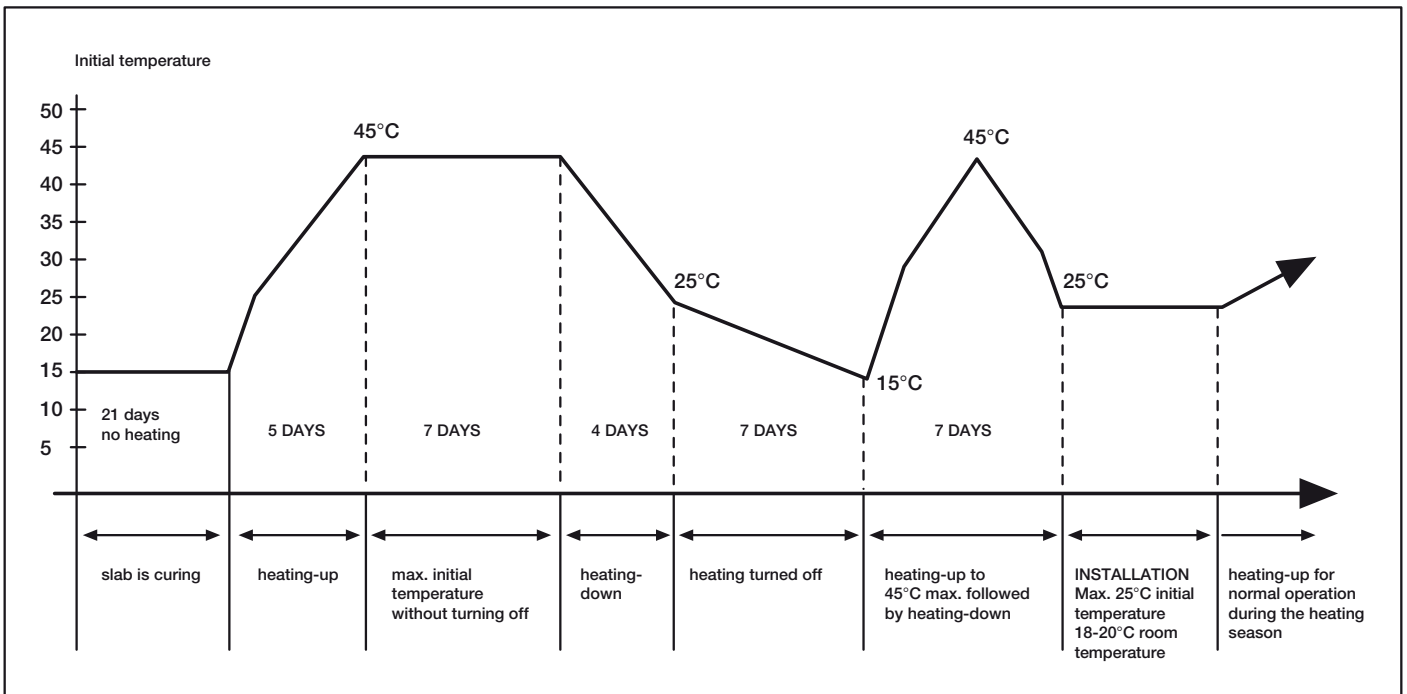

Keep in mind that the optimum surface temperature of your laminate flooring should not exceed 25°C (maximum 28°C).

Heating protocol for hot-water-type subfloor heating systems (Sample)

With newly installed subfloor heating systems the completion of a heating protocol is imperative.

1. a) Work on the floor slab/ concrete floor was completed on _____ .
- b) The floor material is cement screed , anhydrite flow screed .
- c) The average thickness of the screed layer is _____ cm.
2. a) The radiant heated floor construction was put into operation on _____ and was heated up with a daily temperature increase of 5°C (initial temperature) until 45°C were reached.
- b) This maximum temperature was kept for _____ days (should be: 7 days) without being lowered at night.
- c) From _____ until _____ (should be: 4 days) the initial temperature has been lowered daily by 5°C.
- d) From _____ until _____ (should be: 7 days) the heating system was turned off completely.
- e) On _____ the heating system was put into operation again and the initial temperature of 45°C was reached on _____ .
- f) After the initial temperature of 45°C was reached, that initial temperature was reduced (max. 25°C) in steps of no more than 10°C per day until the room temperature had reached the correct levels required for the installation of laminate and pre-finished timber floors (i.e. approx. 18-20°C).
3. Throughout the heating-up and heating-down process have the rooms been aired without exposing them to draught? yes
4. The last residual moisture measurements on the marked test points showed _____ % residual moisture.
(Permissible values: Anhydrite flow screed max. 0.3 CM %, Cement screed max. 1.5 CM %)
5. With this, we approve the installation of wear layers/ coverings on the radiant heated floor construction.

For the building owner/ contracting entity:

Place / Date / Signature / Company stamp

These instructions are for the information/ consultation of the floor installer / heating contractor and/or the building owner. They do not constitute a base from which warranty claims may be derived. In cases of doubt, the respective regulations of the heating contractor/ composition floor layer are to be followed.

Checklist for all-over adhesion of Parador Click-Laminate Flooring

An installation alternative for Parador Laminate Flooring is all-over adhesion. Compared to the installation as a floating floor this method provides a number of advantages. Please note the following information/ recommendations:

- For all-over adhesion on the subfloor you must only use adhesives that are explicitly recommended for this purpose by the manufacturer. Use one- or two component (1-K or 2-K) Polyurethane-adhesives that do not contain any water or solvents. If using solvent-containing adhesives they should comply with DIN 281. Always stick to the manufacturer's instructions especially those on adhesive application.
- Parador recommends the adhesive product T-54 FC by SikaBond. With more specific questions, please consult the adhesive manufacturer and follow the instructions provided on the respective technical data sheet.
- Make sure the substrate is clean, dry, perfectly even, free of cracks and suitable for all-over adhesion, also the respective moisture levels must not be exceeded. Preparatory measures vary among adhesive manufacturers.

- Screed floors must not exceed the following residual moisture levels:

	Anhydrite flow screed	Cement screed
without subfloor heating	max. 0.5 CM %	max. 2.0 CM %
with subfloor heating	max. 0.3 CM %	max. 1.5 CM %

- An expansion gap of at least 10mm is required towards all fixed constructional parts (see Installation rules 6&7).
- Existing expansion gaps in the substrate should be adopted. Additional expansion joints are needed with all door openings, between rooms, at entrances and every 15m (length- or widthwise).
- As with all other installation methods, please follow the general installation instructions with all-over adhesion, too.
- Further information can be obtained on the adhesive manufacturer's website (e.g. www.sika.de) or you may also contact Parador's Applications Technology department.

Many other topics all about modern home living, such as individual flooring concepts, creative wall and ceiling decoration, as well as useful accessories can be found in separate catalogues, available to order at www.parador.eu

Parador GmbH & Co. KG
Millenkamp 7-8
48653 Coesfeld
Germany

Information hotline: +44 (0) 191 2597801
info@parador.de
www.parador.eu

As at 01/2011 © Parador
Errors and changes excepted.
Medienkennung: 123456